

# 7VM333M-RZ

AMD Sempron™ /Athlon™ /Athlon™ XP/Duron™ Socket A Processor Motherboard

## User's Manual

Rev. 1004

12ME-VM333MRZ-1004

### **Copyright**

© 2004 GIGABYTE TECHNOLOGY CO., LTD

Copyright by **GIGA-BYTE TECHNOLOGY CO., LTD.** ("GBT"). No part of this manual may be reproduced or transmitted in any form without the expressed, written permission of GBT.

### **Trademarks**

Third-party brands and names are the property of their respective owners.

### **Notice**

Please do not remove any labels on motherboard, this may void the warranty of this motherboard.

Due to rapid change in technology, some of the specifications might be out of date before publication of this booklet.

The author assumes no responsibility for any errors or omissions that may appear in this document nor does the author make a commitment to update the information contained herein.

### Declaration of Conformity

By the undersigned:

011 East 22nd Street  
Alhambra, CA 91803  
Subject: This product

Complies with the following FCC Part 15 rules:

7WV333ARZ  
FCC Part 15.107(a) and (b), and Part 15.109(a)

FCC Part 15.107(a)

Limit on the field strength of radio frequency emissions from unlicensed digital devices in the 30 MHz to 1 GHz range.

FCC Part 15.107(b)

Limit on the field strength of radio frequency emissions from unlicensed digital devices in the 30 MHz to 1 GHz range.

FCC Part 15.109(a)

Limit on the field strength of radio frequency emissions from unlicensed digital devices in the 30 MHz to 1 GHz range.

FCC Part 15.109(b)

Limit on the field strength of radio frequency emissions from unlicensed digital devices in the 30 MHz to 1 GHz range.

FCC Part 15.107(a) and (b)

Limit on the field strength of radio frequency emissions from unlicensed digital devices in the 30 MHz to 1 GHz range.

FCC Part 15.109(a)

Limit on the field strength of radio frequency emissions from unlicensed digital devices in the 30 MHz to 1 GHz range.

FCC Part 15.107(a) and (b)

Limit on the field strength of radio frequency emissions from unlicensed digital devices in the 30 MHz to 1 GHz range.

FCC Part 15.109(a)

Limit on the field strength of radio frequency emissions from unlicensed digital devices in the 30 MHz to 1 GHz range.

FCC Part 15.107(a) and (b)

Limit on the field strength of radio frequency emissions from unlicensed digital devices in the 30 MHz to 1 GHz range.

FCC Part 15.109(a)

Limit on the field strength of radio frequency emissions from unlicensed digital devices in the 30 MHz to 1 GHz range.

FCC Part 15.107(a) and (b)

Limit on the field strength of radio frequency emissions from unlicensed digital devices in the 30 MHz to 1 GHz range.

FCC Part 15.109(a)

Limit on the field strength of radio frequency emissions from unlicensed digital devices in the 30 MHz to 1 GHz range.

FCC Part 15.107(a) and (b)

Limit on the field strength of radio frequency emissions from unlicensed digital devices in the 30 MHz to 1 GHz range.

FCC Part 15.109(a)

Limit on the field strength of radio frequency emissions from unlicensed digital devices in the 30 MHz to 1 GHz range.

FCC Part 15.107(a) and (b)

Limit on the field strength of radio frequency emissions from unlicensed digital devices in the 30 MHz to 1 GHz range.

FCC Part 15.109(a)

Limit on the field strength of radio frequency emissions from unlicensed digital devices in the 30 MHz to 1 GHz range.

FCC Part 15.107(a) and (b)

Limit on the field strength of radio frequency emissions from unlicensed digital devices in the 30 MHz to 1 GHz range.

FCC Part 15.109(a)

Limit on the field strength of radio frequency emissions from unlicensed digital devices in the 30 MHz to 1 GHz range.

FCC Part 15.107(a) and (b)

Limit on the field strength of radio frequency emissions from unlicensed digital devices in the 30 MHz to 1 GHz range.

FCC Part 15.109(a)

Limit on the field strength of radio frequency emissions from unlicensed digital devices in the 30 MHz to 1 GHz range.

Model No.

Date: Mar. 17, 2004

Signature: James Hester

### DECLARATION OF CONFORMITY

For FCC Part 2, Section 2.1077(b)



Responsible Party Name: G.B.L.T. INC. (U.S.A.)

Address: 17358 Railroad Street

City of Industry, CA 91748

Phone/Fax No: (818) 854-9338 (818) 854-9339

herby declares that the product

Product Name: **Motherboard**

Model Number: **7VM333M-RZ**

Confirms to the following specifications:

FCC Part 15, Subpart B, Section 15.107(b) and Section 15.109

(a) Class B Digital Device

Supplementary Information:

This device complies with part 15 of the FCC Rules. Operation is subject to the following two conditions: (1) This device may not cause harmful (and (2) this device must accept any interference received, including that may cause undesired operation.

Representative Person's Name: ERIC LIU

Signature: Eric Liu

Date: Mar. 17, 2004

## Preparing Your Computer

Computer motherboards and expansion cards contain very delicate Integrated Circuit (IC) chips. To protect them against damage from static electricity, you should follow some precautions whenever you work on your computer.

1. Unplug your computer when working on the inside.
2. Use a grounded wrist strap before handling computer components. If you do not have one, touch both of your hands to a safely grounded object or to a metal object, such as the power supply case.
3. Hold components by the edges and try not touch the IC chips, leads or connectors, or other components.
4. Place components on a grounded antistatic pad or on the bag that came with the components whenever the components are separated from the system.
5. Ensure that the ATX power supply is switched off before you plug in or remove the ATX power connector on the motherboard.



## Installing the motherboard to the chassis

If the motherboard has mounting holes, but they don't line up with the holes on the base and there are no slots to attach the spacers, do not become alarmed you can still attach the spacers to the mounting holes. Just cut the bottom portion of the spacers (the spacer may be a little hard to cut off, so be careful of your hands). In this way you can still attach the motherboard to the base without worrying about short circuits. Sometimes you may need to use the plastic springs to isolate the screw from the motherboard PCB surface, because the circuit wire may be near by the hole. Be careful, don't let the screw contact any printed circuit write or parts on the PCB that are near the fixing hole, otherwise it may damage the board or cause board malfunctioning.

# Table of Contents

Chapter 1 Introduction .....	5
Features Summary .....	5
7VM333M-RZ Motherboard Layout .....	6
Block Diagram .....	7
Hardware Installation Process .....	8
Step 1: Set System Jumper (JP1) .....	8
Step 2: Install the Central Processing Unit (CPU) .....	9
Step 2-1: CPU Installation .....	9
Step 2-2: CPU Cooling Fan Installation .....	9
Step 3: Install Memory Modules .....	10
Step 4: Install AGP Card .....	11
Step 5: Install I/O Peripherals Cabels .....	11
Step 5-1: I/O Back Panel Introduction .....	11
Step 5-2: Connectors Introduction .....	12
 Chapter 2 BIOS Setup .....	 19
The Main Menu (For example: BIOS Ver. : FAa) .....	19
Standard CMOS Features .....	21
Advanced BIOS Features .....	23
Integrated Peripherals .....	24
Power Management Setup .....	26
PnP/PCI Configurations .....	27
PC Health Status .....	28
Frequency/Voltage Control .....	29
Load Fail-Safe Defaults .....	30
Load Optimized Defaults .....	30
Set Supervisor/User Password .....	31
Save & Exit Setup .....	32
Exit Without Saving .....	32
 Chapter 3 Driver Installation .....	 33

# Chapter 1 Introduction

## Features Summary

CPU	<ul style="list-style-type: none"> <li>• Socket A for AMD Sempron™/Athlon™ XP/Athlon™ / Duron™ processor</li> <li>• 200/266/333MHz FSB</li> <li>• Supports 1.4GHz and faster</li> </ul>
Chipset	<ul style="list-style-type: none"> <li>• Northbridge : VIA KM266 Pro</li> <li>• Southbridge : VIA VT8235/VT8237R</li> </ul>
Memory	<ul style="list-style-type: none"> <li>• 2 184-pin DDR DIMM sockets, supports up to 2GB DRAM (Max)</li> <li>• Supports DDR333/DDR266/DDR200 DIMM</li> <li>• Supports only 2.5V DDR DIMM</li> </ul>
Slots	<ul style="list-style-type: none"> <li>• 1 AGP slot supports 4X(1.5V) mode</li> <li>• 3 PCI slots</li> </ul>
On-Board IDE	<ul style="list-style-type: none"> <li>• 2 IDE controller provide IDE HDD/CD-ROM (IDE1, IDE2) with PIO, Bus Master (Ultra DMA33/ATA66/ATA100/ATA133) operation modes</li> <li>• Can connect up to 4 IDE devices</li> </ul>
On-Board Floppy	<ul style="list-style-type: none"> <li>• 1 Floppy port supports 2 FDD with 360K, 720K, 1.2M, 1.44M and 2.88M bytes</li> </ul>
On-Board Peripherals	<ul style="list-style-type: none"> <li>• 1 Parallel port</li> <li>• 1 Serial port (COMA), 1 VGA port, COMB on-board</li> <li>• 6 USB 2.0/1.1 ports (2 x Rear, 4 x Front by cable)</li> <li>• 1 Front Audio connector</li> <li>• 1 PS/2 Keyboard</li> <li>• 1 PS/2 Mouse</li> </ul>
On-Board VGA	<ul style="list-style-type: none"> <li>• Built-in VIA KM266 Pro</li> </ul>
On-Board LAN	<ul style="list-style-type: none"> <li>• Built-in VIA VT6103 chipset</li> <li>• 1 RJ45 port</li> </ul>
On-Board Sound	<ul style="list-style-type: none"> <li>• VIA VT1617</li> <li>• Supports 2/4/6-channel</li> <li>• Line Out / Line In / Mic In</li> <li>• SPDIF Out</li> <li>• CD In / Game connector</li> </ul>
BIOS	<ul style="list-style-type: none"> <li>• Licensed AWARD BIOS</li> <li>• Supports Q-Flash™</li> </ul>
I/O Control	<ul style="list-style-type: none"> <li>• ITE8705</li> </ul>
Hardware Monitor	<ul style="list-style-type: none"> <li>• CPU/System fan revolution detect</li> <li>• CPU/System temperature detect</li> <li>• System voltage detect</li> <li>• CPU/System fan fail warning</li> </ul>
Additional Features	<ul style="list-style-type: none"> <li>• Supports @BIOS™</li> <li>• Supports EasyTune™</li> </ul>
Overclocking	<ul style="list-style-type: none"> <li>• Over clock (CPU/DDR) by BIOS</li> <li>• Over voltage (DDR/AGP) br BIOS</li> </ul>
Form Factor	<ul style="list-style-type: none"> <li>• Micro ATX size form factor, 24.4cm x 22.3cm</li> </ul>

# 7VM333M-RZ Motherboard Layout

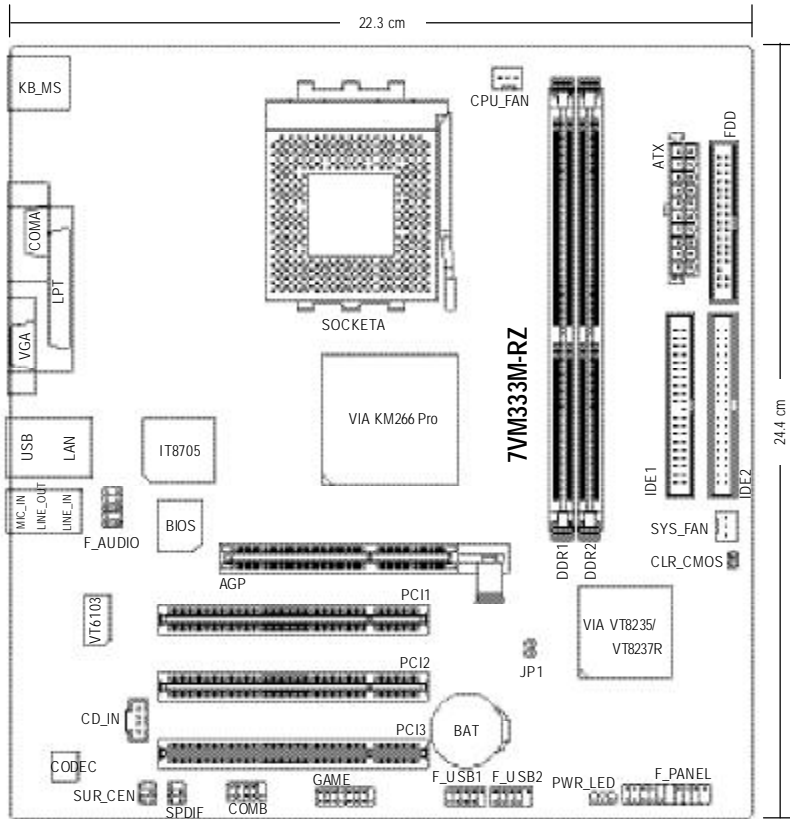

# Block Diagram

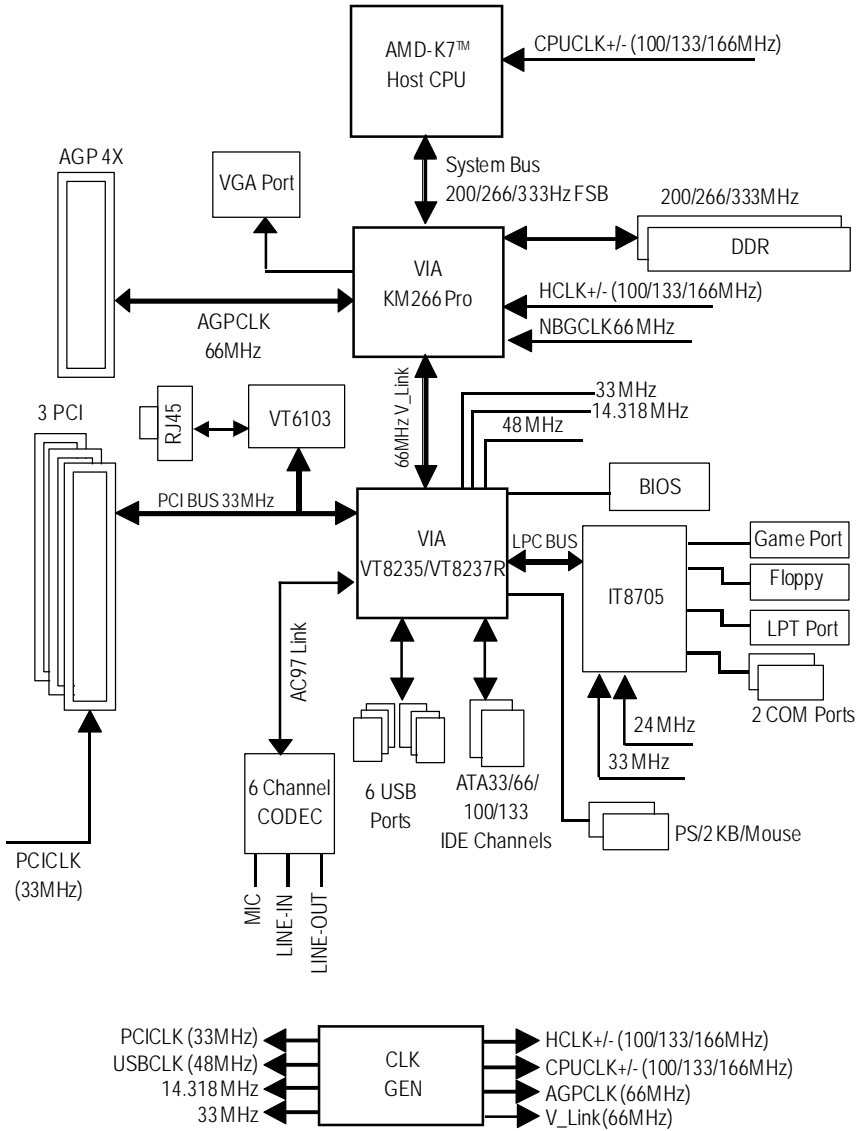

# Hardware Installation Process

To set up your computer, you must complete the following steps:

- Step 1- Set System Jumper (JP1)
- Step 2- Install the Central Processing Unit (CPU)
- Step 3- Install Memory Modules
- Step 4- Install Expansion Cards
- Step 5- Install I/O Peripherals Cables

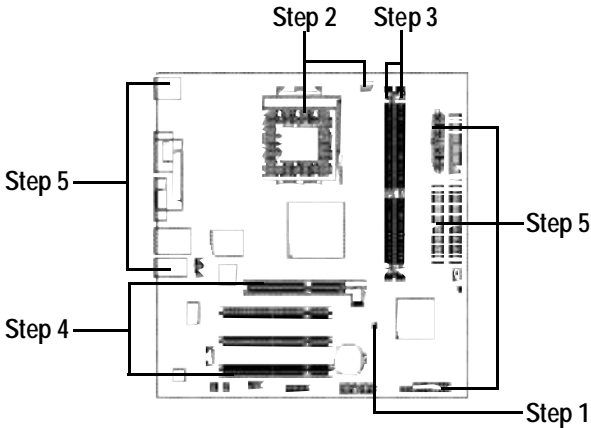

## Step 1: Set System Jumper (JP1)

The system bus frequency can be switched at 100/133/166MHz by adjusting system jumper (JP1).  
(The internal frequency depend on CPU.)

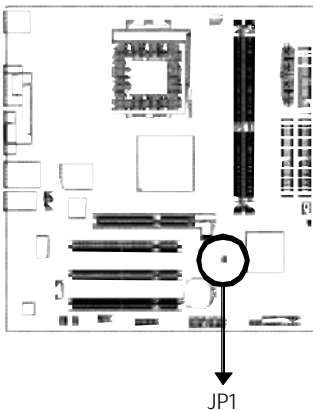

Short: 100MHz  
1

Open: 133/166MHz  
1

100MHz : Fix FSB 200MHz CPU

133/166MHz : Supports FSB 266/333MHz CPU



CAUTION

If you want to use a CPU with 200MHz FSB, please set JP1 to 100MHz.



## Step 2: Install the Central Processing Unit (CPU)



Before installing the processor, adhere to the following warning:

1. Please make sure the CPU type is supported by the motherboard.
2. The processor will overheat without the heatsink and/or fan, resulting in permanent irreparable damage.
3. If you do not match the CPU socket Pin 1 and CPU cut edge well, it will cause improper installation. Please change the insert orientation.
4. Apply thermal grease between the processor and cooling fan.
5. Never run the processor without the heatsink properly and firmly attached. Permanent damage will result.
6. Please set the CPU host frequency in accordance with your processor's specifications.

We don't recommend you to set the system bus frequency over the CPU's specification because these specific bus frequencies are not the standard specifications for CPU, chipset and most of the peripherals. Whether your system can run under these specific bus frequencies properly will depend on your hardware configurations, including CPU, Memory, Cards... etc.

### Step 2-1: CPU Installation

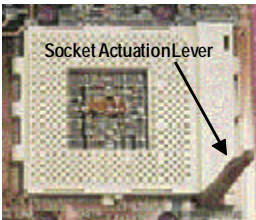

Figure 1.

Pull the rod to the 90-degree directly.

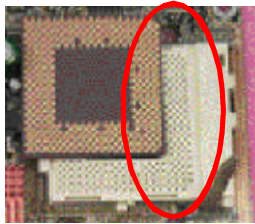

Figure 2.

Locate Pin 1 in the socket and look for a cut edge on the CPU upper corner. Insert the CPU into the socket. (Do not force the CPU into the socket.) Then move the socket lever to the locked position while holding pressure on the center of the CPU.

### Step 2-2: CPU Cooling Fan Installation

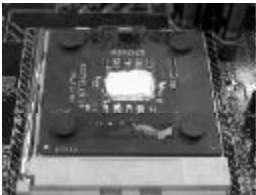

Figure 1.

Apply the thermal tape(or grease) to provide better heat conduction between your CPU and cooling fan.

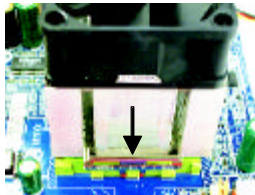

Figure 2.

Fasten the cooling fan supporting-base onto the CPU socket on the motherboard.

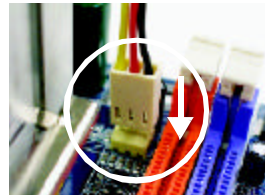

Figure 3.

Make sure the CPU fan is plugged to the CPU fan connector, than the install completely.

## Step 3: Install Memory Modules



Before installing the memory modules, adhere to the following warning:

1. Please note that the DIMM module can only fit in one direction due to the one notch. Wrong orientation will cause improper installation. Please change the insert orientation.

The motherboard has 2 dual inline memory module (DIMM) sockets. The BIOS will automatically detects memory type and size. To install the memory module, just push it vertically into the DIMM socket. The DIMM module can only fit in one direction due to the notch. Memory size can vary between sockets.

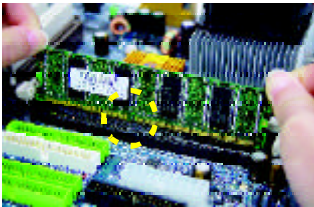
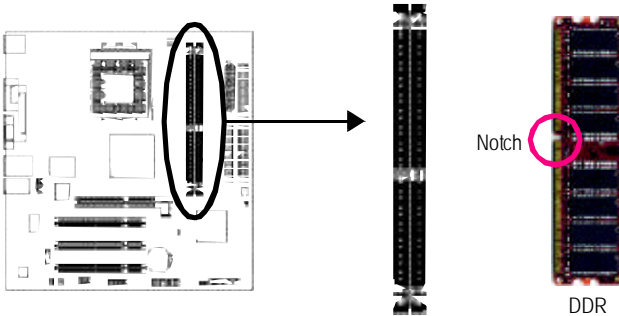

1. The DIMM socket has a notch, so the DIMM memory module can only fit in one direction.



2. Insert the DIMM memory module vertically into the DIMM socket. Then push it down.



3. Close the plastic clip at both edges of the DIMM sockets to lock the DIMM module. Reverse the installation steps when you wish to remove the DIMM module.

## Step 4: Install AGP Card

1. Read the relate AGP card's instruction document before install the AGP card into the computer.
2. If your AGP card has "AGP 4X(1.5V) notch"(show below), please make sure your AGP card is AGP 4X(1.5V).



3. Please carefully pull out the small white-drawable bar at the end of the AGP slot when you try to install/uninstall the AGP card. Please align the AGP card to the onboard AGP slot and press firmly down on the slot. Make sure your AGP card is locked by the small white-drawable bar.

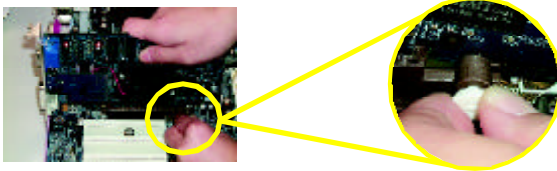

## Step 5: Install I/O Peripherals Cables

### Step 5-1: I/O Back Panel Introduction

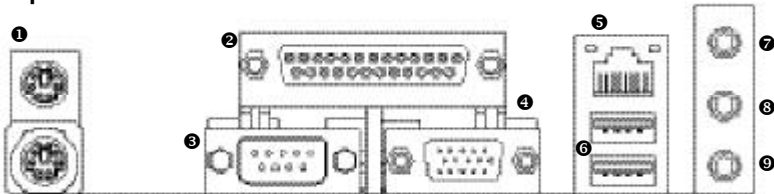

- 1 PS/2 Keyboard and PS/2 Mouse connector**  
 This connector supports standard PS/2 keyboard and PS/2 mouse.
- 2 Parallel port (LPT)**  
 Device like printer can be connected to Parallel port.
- 3 Serial port (COMA)**  
 Mouse and modem etc. can be connected to Serial port.
- 4 VGA port**  
 Monitor can be connected to VGA port.
- 5 LAN port**  
 LAN is fast Ethernet with 10/100Mbps speed.
- 6 USB port**  
 Before you connect your device(s) into USB connector(s), please make sure your device(s) such as USB keyboard, mouse, scanner, zip, speaker...etc. Have a standard USB interface. Also make sure your OS supports USB controller. If your OS does not support USB controller, please contact OS vendor for possible patch or driver upgrade. For more information please contact your OS or device(s) vendors.
- 7 Line In jack**  
 Devices like CD-ROM, walkman etc. can be connected to Line In jack.

### 8 Line Out jack

Connect the stereo speakers or earphone to this connector.

### 9 MIC In jack

Microphone can be connect to MIC In jack.

After installation of the audio driver, you are able to use 2/4/6-channel audio feature by software selection.

You can connect "Front speaker" to "Line Out" jack, Connect "Rear speaker" to "Line In" jack and connect "Center/Subwoofer" to "MIC In" jack.

## Step 5-2: Connectors Introduction

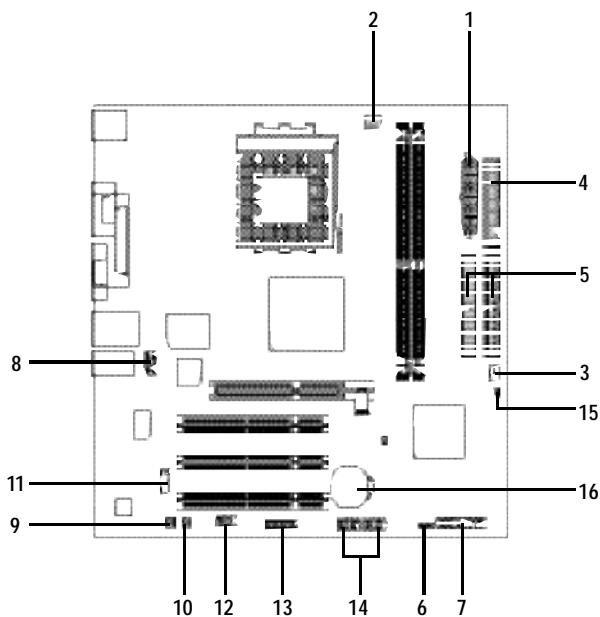

1) ATX	9) SUR_CEN
2) CPU_FAN	10) SPDIF
3) SYS_FAN	11) CD_IN
4) FDD	12) COMB
5) IDE1 / IDE2	13) GAME
6) PWR_LED	14) F_USB1 / F_USB2
7) F_PANEL	15) CLR_CMOS
8) F_AUDIO	16) BAT

## 1) ATX (ATX Power)

AC power cord should only be connected to your power supply unit after ATX power cable and other related devices are firmly connected to the mainboard.

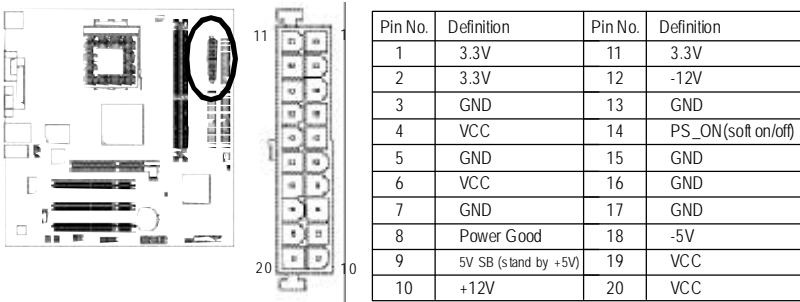

## 2) CPU\_FAN (CPU Fan Connector)

Please note, a proper installation of the CPU cooler is essential to prevent the CPU from running under abnormal condition or damaged by overheating. The CPU fan connector supports Max. current up to 600 mA.

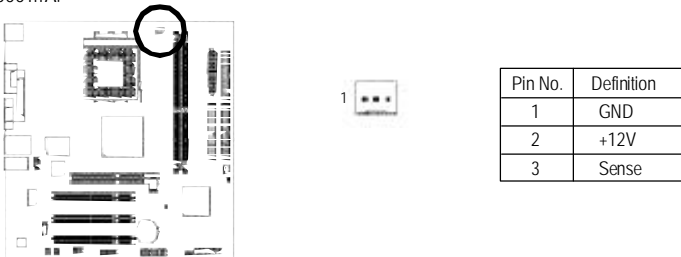

## 3) SYS\_FAN (System Fan Connector)

This connector allows you to link with the cooling fan on the system case to lower the system temperature.

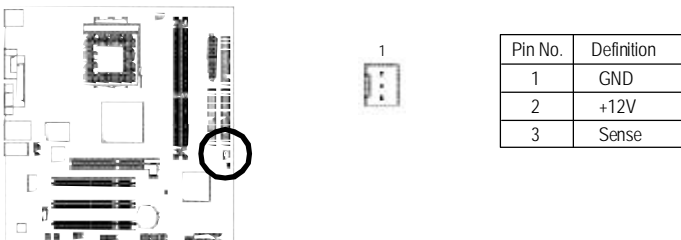

#### 4) FDD(Floppy Connector)

Please connect the floppy drive ribbon cables to FDD. It supports 360K, 1.2M, 720K, 1.44M and 2.88M bytes floppy disk types.

The red stripe of the ribbon cable must be the same side with the Pin1.

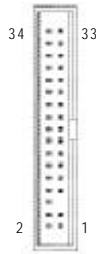
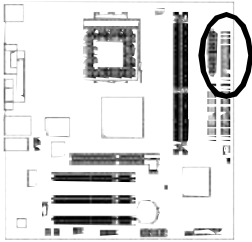

#### 5) IDE1 / IDE2 (IDE1 / IDE2 Connector)

Please connect first hard disk to IDE1 and connect CD-ROM to IDE2.

The red stripe of the ribbon cable must be the same side with the Pin1.

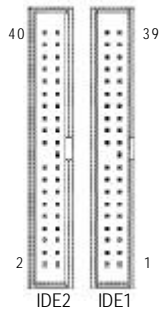
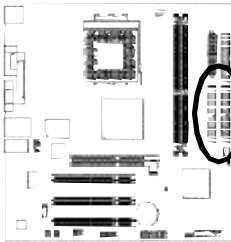

#### 6) PWR\_LED

PWR\_LED is connect with the system power indicator to indicate whether the system is on/off. It will blink when the system enters suspend mode.

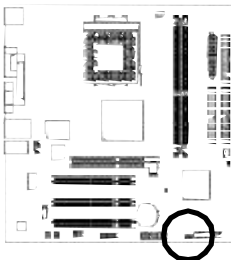

Pin No.	Definition
1	MPD+
2	MPD-
3	MPD-

### 7) F\_PANEL (2 x 10 pins Connector)

Please connect the power LED, PC speaker, reset switch and power switch etc. of your chassis front panel to the F\_PANEL connector according to the pin assignment below.

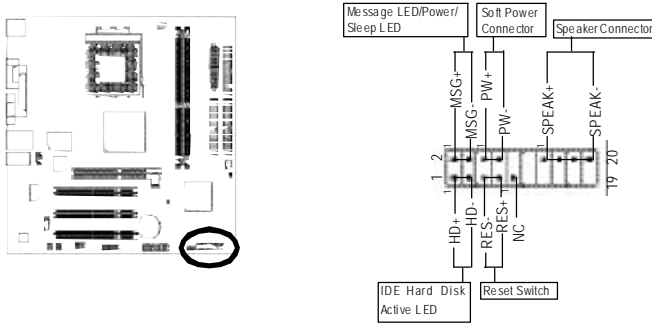

HD (IDE Hard Disk Active LED)	Pin 1 : LED anode(+) Pin 2: LED cathode(-)
SPK(Speaker Connector)	Pin 1: VCC(+) Pin 2- Pin 3: NC Pin 4: Data(-)
RES (Reset Switch)	Open: Normal Operation Close: Reset Hardware System
PW(Soft Power Connector)	Open: Normal Operation Close: Power On/Off
MSG (Message LED/ Power/ Sleep LED)	Pin 1 : LED anode(+) Pin 2: LED cathode(-)
NC	NC

### 8) F\_AUDIO (FrontAudio Connector)

If you want to use FrontAudio connector, you must remove 5-6, 9-10 Jumper.

In order to utilize the front audio header, your chassis must have front audio connector. Also please make sure the pin assignment on the cable is the same as the pin assignment on the MB header. To find out if the chassis you are buying support front audio connector, please contact your dealer. Please note, you can have the alternative of using front audio connector or of using rear audio connector to play sound.

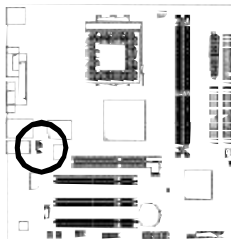

Pin No.	Definition
1	MIC
2	GND
3	REF
4	Power
5	FrontAudio (R)
6	Rear Audio (R)
7	Reserved
8	No Pin
9	FrontAudio (L)
10	Rear Audio (L)

## 9) SUR\_CEN (Surround Center Connector)

Please contact your nearest dealer for optional SUR\_CEN cable.

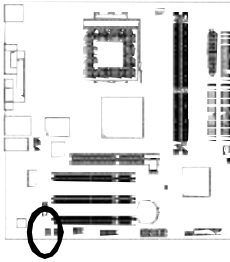

Pin No.	Definition
1	SUROUTL
2	SUROUTR
3	GND
4	No Pin
5	CENTER_OUT
6	BASS_OUT

## 10) SPDIF (SPDIF Out Connector)

The SPDIF output is capable of providing digital audio to external speakers or compressed AC3 data to an external Dolby Digital Decoder. Use this feature only when your stereo system has digital input function. Be careful with the polarity of the SPDIF connector. Check the pin assignment carefully while you connect the SPDIF cable, incorrect connection between the cable and connector will make the device unable to work or even damage it. For optional SPDIF cable, please contact your local dealer.

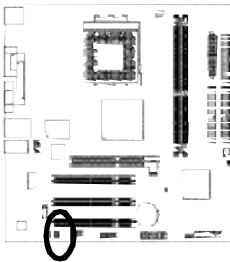

Pin No.	Definition
1	VCC
2	No Pin
3	SPDIF
4	NC
5	GND
6	GND

## 11) CD\_IN (CD In Connector)

Connect CD-ROM or DVD-ROM audio out to the connector.

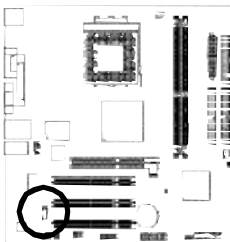

Pin No.	Definition
1	CD-L
2	GND
3	GND
4	CD-R



## 12) COMB (COM B Connector)

Be careful with the polarity of the COMB connector. Check the pin assignment carefully while you connect the COMB cable, incorrect connection between the cable and connector will make the device unable to work or even damage it. For optional COMB cable, please contact your local dealer.

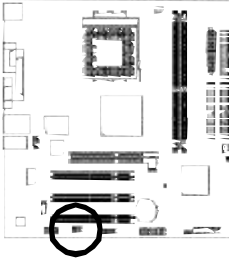

Pin No.	Definition
1	NDCDB-
2	NSINB
3	NSOUTB
4	NDTRB-
5	GND
6	NDSRB-
7	NRTSB-
8	NCTSB-
9	NRIB-
10	No Pin

## 13) GAME (Game Connector)

This connector supports joystick, MIDI keyboard and other relate audio devices. Check the pin assignment while you connect the game cables. Please contact your nearest dealer for optional game cables.

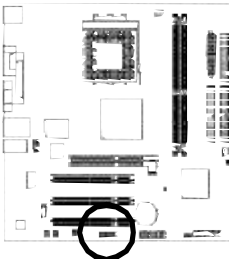

Pin No.	Definition	Pin No.	Definition
1	VCC	9	GPSA1
2	GRX1_R	10	GND
3	GND	11	GRY1_R
4	GPSA2	12	VCC
5	VCC	13	GPSB1
6	GRX2_R	14	MSO_R
7	GRY2_R	15	GPSB2
8	MSL_R	16	No Pin

## 14) F\_USB1 / F\_USB2 (Front USB Connector)

Be careful with the polarity of the front USB connector. Check the pin assignment carefully while you connect the front USB cable, incorrect connection between the cable and connector will make the device unable to work or even damage it. For optional front USB cable, please contact your local dealer.

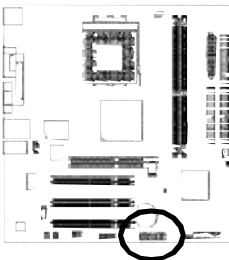

Pin No.	Definition
1	Power
2	Power
3	USB Dx-
4	USB Dy-
5	USB Dx+
6	USB Dy+
7	GND
8	GND
9	No Pin
10	NC

## 15) CLR\_CMOS (Clear CMOS)

You may clear the CMOS data to its default values by this jumper. To clear CMOS, temporarily short 1-2 pin. Default doesn't include the "Shunter" to prevent from improper use this jumper.

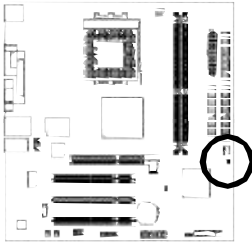

1-2 close: Clear CMOS



Open: Normal

## 16) BAT (Battery)

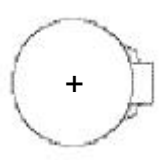
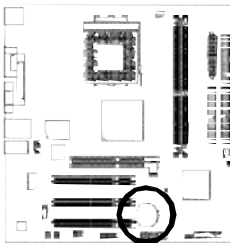

### CAUTION

- ❖ Danger of explosion if battery is incorrectly replaced.
- ❖ Replace only with the same or equivalent type recommended by the manufacturer.
- ❖ Dispose of used batteries according to the manufacturer's instructions.

If you want to erase CMOS...

1. Turn OFF the computer and unplug the power cord.
2. Remove the battery, wait for 30 second.
3. Re-install the battery.
4. Plug the power cord and turn ON the computer.

## Chapter 2 BIOS Setup

BIOS Setup is an overview of the BIOS Setup Program. The program that allows users to modify the basic system configuration. This type of information is stored in battery-backed CMOS RAM so that it retains the Setup information when the power is turned off.

### ENTERING SETUP

Powering ON the computer and pressing <Del> immediately will allow you to enter Setup. If you require more advanced BIOS settings, please go to "Advanced BIOS" setting menu. To enter Advanced BIOS setting menu, press "Ctrl+F1" key on the BIOS screen.

### CONTROL KEYS

<↑><↓><←><→>	Move to select item
<Enter>	Select Item
<Esc>	Main Menu - Quit and not save changes into CMOS Status Page Setup Menu and Option Page Setup Menu - Exit current page and return to Main Menu
<+/PgUp>	Increase the numeric value or make changes
<-/PgDn>	Decrease the numeric value or make changes
<F1>	General help, only for Status Page Setup Menu and Option Page Setup Menu
<F2>	Item Help
<F5>	Restore the previous CMOS value from CMOS, only for Option Page Setup Menu
<F6>	Load the file-safe default CMOS value from BIOS default table
<F7>	Load the Optimized Defaults
<F8>	Q-Flash utility
<F9>	System Information
<F10>	Save all the CMOS changes, only for Main Menu

### Main Menu

The on-line description of the highlighted setup function is displayed at the bottom of the screen.

### Status Page Setup Menu / Option Page Setup Menu

Press F1 to pop up a small help window that describes the appropriate keys to use and the possible selections for the highlighted item. To exit the Help Window press <Esc>.

## The Main Menu (For example: BIOS Ver. : F1)

Once you enter Award BIOS CMOS Setup Utility, the Main Menu (as figure below) will appear on the screen. The Main Menu allows you to select from eight setup functions and two exit choices. Use arrow keys to select among the items and press <Enter> to accept or enter the sub-menu.

CMOS Setup Utility-Copyright (C) 1984-2004 Award Software

<ul style="list-style-type: none"> <li>▶ Standard CMOS Features</li> <li>▶ Advanced BIOS Features</li> <li>▶ Integrated Peripherals</li> <li>▶ Power Management Setup</li> <li>▶ PnP/PCI Configurations</li> <li>▶ PC Health Status</li> <li>▶ Frequency/Voltage Control</li> </ul>	<ul style="list-style-type: none"> <li>Load Fail-Safe Defaults</li> <li>Load Optimized Defaults</li> <li>Set Supervisor Password</li> <li>Set User Password</li> <li>Save &amp; Exit Setup</li> <li>Exit Without Saving</li> </ul>
ESC: Quit	↑↓→←: Select Item
F8: Q-Flash	F10: Save & Exit Setup
Time, Date, Hard Disk Type...	



If you can't find the setting you want, please press "Ctrl+F1" to search the advanced option hidden.

- **Standard CMOS Features**  
This setup page includes all the items in standard compatible BIOS.
- **Advanced BIOS Features**  
This setup page includes all the items of Award special enhanced features.
- **Integrated Peripherals**  
This setup page includes all onboard peripherals.
- **Power Management Setup**  
This setup page includes all the items of Green function features.
- **PnP/PCI Configuration**  
This setup page includes all the configurations of PCI & PnP ISA resources.
- **PC Health Status**  
This setup page is the System auto detect Temperature, voltage, fan, speed.
- **Frequency/Voltage Control**  
This setup page is control CPU clock and frequency ratio.
- **Load Fail-Safe Defaults**  
Fail-Safe Defaults indicates the value of the system parameters which the system would be in safe configuration.
- **Load Optimized Defaults**  
Optimized Defaults indicates the value of the system parameters which the system would be in best performance configuration.
- **Set Supervisor Password**  
Change, set, or disable password. It allows you to limit access to the system and Setup, or just to Setup.
- **Set User Password**  
Change, set, or disable password. It allows you to limit access to the system.
- **Save & Exit Setup**  
Save CMOS value settings to CMOS and exit setup.
- **Exit Without Saving**  
Abandon all CMOS value changes and exit setup.

# Standard CMOS Features

CMOS Setup Utility-Copyright (C) 1984-2004 Award Software  
Standard CMOS Features

Date (mm:dd:yy)	Thu, Jan 15 2004	Item Help
Time (hh:mm:ss)	22:31:24	Menu Level ▶
▶ IDE Primary Master	[None]	Change the day, month, year
▶ IDE Primary Slave	[None]	<Week>
▶ IDE Secondary Master	[None]	Sun. to Sat.
▶ IDE Secondary Slave	[None]	<Month>
Drive A	[1.44M, 3.5"]	Jan. to Dec.
Drive B	[None]	<Day>
Floppy 3 Mode Support	[Disabled]	1 to 31 (or maximum allowed in the month)
Holt On	[All, But Keyboard]	<Year>
Base Memory	640K	1999 to 2098
Extended Memory	127M	
Total Memory	128M	
↑↓→←: Move    Enter: Select    +/-/PU/PD: Value    F10: Save    ESC: Exit    F1: General Help F5: Previous Values    F6: Fail-Save Default    F7: Optimized Defaults		

## ☛ Date

The date format is <week>, <month>, <day>, <year>.

- ▶▶ Week    The week, from Sun to Sat, determined by the BIOS and is display only
- ▶▶ Month    The month, Jan. Through Dec.
- ▶▶ Day        The day, from 1 to 31 (or the maximum allowed in the month)
- ▶▶ Year        The year, from 1999 through 2098

## ☛ Time

The times format in <hour> <minute> <second>. The time is calculated base on the 24-hour military-time clock. For example, 1 p.m. is 13:00:00.

## ☛ IDE Primary Master, Slave / IDE Secondary Master, Slave

The category identifies the types of hard disk from drive C to F that has been installed in the computer. There are two types: auto type, and manual type. Manual type is user-definable; Auto type which will automatically detect HDD type.

Note that the specifications of your drive must match with the drive table. The hard disk will not work properly if you enter improper information for this category.

If you select User Type, related information will be asked to enter to the following items. Enter the information directly from the keyboard and press <Enter>. Such information should be provided in the documentation from your hard disk vendor or the system manufacturer.

- ▶▶ Cylinder    Number of cylinders
- ▶▶ Head        Number of heads
- ▶▶ Precomp    Write precomp
- ▶▶ Landing Zone    Landing zone
- ▶▶ Sector      Number of sectors

If a hard disk has not been installed, select NONE and press <Enter>.

### ☛ Drive A / Drive B

The category identifies the types of floppy disk drive A or drive B that has been installed in the computer.

- ▶▶ None No floppy drive installed
- ▶▶ 360K, 5.25" 5.25 inch PC-type standard drive; 360K byte capacity.
- ▶▶ 1.2M, 5.25" 5.25 inch AT-type high-density drive; 1.2M byte capacity (3.5 inch when 3 Mode is Enabled).
- ▶▶ 720K, 3.5" 3.5 inch double-sided drive; 720K byte capacity
- ▶▶ 1.44M, 3.5" 3.5 inch double-sided drive; 1.44M byte capacity.
- ▶▶ 2.88M, 3.5" 3.5 inch double-sided drive; 2.88M byte capacity.

### ☛ Floppy 3 Mode Support (for Japan Area)

- ▶▶ Disabled Normal Floppy Drive. (Default value)
- ▶▶ Drive A Drive A is 3 mode Floppy Drive.
- ▶▶ Drive B Drive B is 3 mode Floppy Drive.
- ▶▶ Both Drive A & B are 3 mode Floppy Drives.

### ☛ Halt on

The category determines whether the computer will stop if an error is detected during power up.

- ▶▶ No Errors The system boot will not stop for any error that may be detected and you will be prompted.
- ▶▶ All Errors Whenever the BIOS detects a non-fatal error the system will be stopped.
- ▶▶ All, But Keyboard The system boot will not stop for a keyboard error; it will stop for all other errors. (Default value)
- ▶▶ All, But Diskette The system boot will not stop for a disk error; it will stop for all other errors.
- ▶▶ All, But Disk/Key The system boot will not stop for a keyboard or disk error; it will stop for all other errors.

### ☛ Memory

The category is display-only which is determined by POST (Power On Self Test) of the BIOS.

#### ▶▶ Base Memory

The POST of the BIOS will determine the amount of base (or conventional) memory installed in the system.

The value of the base memory is typically 512K for systems with 512K memory installed on the motherboard, or 640K for systems with 640K or more memory installed on the motherboard.

#### ▶▶ Extended Memory

The BIOS determines how much extended memory is present during the POST.

This is the amount of memory located above 1 MB in the CPU's memory address map.

# Advanced BIOS Features

CMOS Setup Utility-Copyright (C) 1984-2004 Award Software  
Advanced BIOS Features

First Boot Device	[Floppy]	Item Help
Second Boot Device	[HDD-0]	Menu Level ▶
Third Boot Device	[CDROM]	Select Boot Device priority
Password Check	[Setup]	[Floppy] Boot from floppy
		[LS120] Boot from LS120
		[HDD-0] Boot from First HDD
		[HDD-1] Boot from Second HDD
↑↓→←: Move    Enter: Select    +/~/PU/PD: Value    F10: Save    ESC: Exit    F1: General Help F5: Previous Values    F6: Fail-Save Default    F7: Optimized Defaults		

## First / Second / Third Boot Device

- ▶▶ Floppy      Select your boot device priority by Floppy.
- ▶▶ LS120      Select your boot device priority by LS120.
- ▶▶ HDD-0~3    Select your boot device priority by HDD-0~3.
- ▶▶ SCSI        Select your boot device priority by SCSI.
- ▶▶ CDROM      Select your boot device priority by CDROM.
- ▶▶ ZIP         Select your boot device priority by ZIP.
- ▶▶ USB-FDD    Select your boot device priority by USB-FDD.
- ▶▶ USB-ZIP    Select your boot device priority by USB-ZIP.
- ▶▶ USB-CDROM Select your boot device priority by USB-CDROM.
- ▶▶ USB-HDD    Select your boot device priority by USB-HDD.
- ▶▶ LAN         Select your boot device priority by LAN.
- ▶▶ Disabled    Select your boot device priority by Disabled.

## Password Check

- ▶▶ System      The system can not boot and can not access to Setup page w ill be denied if the correct password is not entered at the prompt.
- ▶▶ Setup        The system will boot, but access to Setup will be denied if the correct password is not entered at the prompt. (Default v alue)

# Integrated Peripherals

CMOS Setup Utility-Copyright (C) 1984-2004 Award Software  
Integrated Peripherals

On-Chip IDE Channel0	[Enabled]	Item Help
On-Chip IDE Channel1	[Enabled]	Menu Level ▶
AC'97 Audio	[Auto]	If a hard disk controller card is used, set at Disabled
VIA Onboard LAN	[Enabled]	
USB 1.1 Controller	[Enabled]	
USB 2.0 Controller	[Enabled]	
USB Keyboard Support	[Disabled]	
USB Mouse Support	[Disabled]	
On-Chip LAN Boot ROM	[Disabled]	[Enabled] Enable onboard IDE channel
Onboard Serial Port 1	[3F8/IR04]	
Onboard Serial Port 2	[2F8/IR03]	
Onboard Parallel Port	[378/IR07]	[Disabled] Disable onboard IDE channel
Parallel Port Mode	[SPP]	
Game Port Address	[201]	
Midi Port Address	[Disabled]	
Midi Port IRQ	[10]	
↑↓→←: Move    Enter: Select    +/~/PU/PD: Value    F10: Save    ESC: Exit    F1: General Help F5: Previous Values    F6: Fail-Save Default    F7: Optimized Defaults		

## ☞ On-Chip IDE Channel0

When set at "Enabled", it allows you to use the onboard primary PCI IDE. If a hard disk controller card is used, please set at "Disabled".

- ▶ Enabled      Enable onboard 1st channel IDE port. (Default value)
- ▶ Disabled     Disable onboard 1st channel IDE port.

## ☞ On-Chip IDE Channel1

When set at "Enabled", it allows you to use the onboard secondary PCI IDE. If a hard disk controller card is used, please set at "Disabled".

- ▶ Enabled      Enable onboard 2nd channel IDE port. (Default value)
- ▶ Disabled     Disable onboard 2nd channel IDE port.

## ☞ AC'97 Audio

- ▶ Enabled      Enable onboard AC'97 audio function. (Default value)
- ▶ Disabled     Disable this function.

## ☞ VIA Onboard LAN

- ▶ Enabled      Enable onboard LAN function. (Default value)
- ▶ Disabled     Disable this function.

## ☞ USB 1.1 Controller

Disable this function if you are not using the onboard USB feature.

- ▶ Enabled      Enable USB 1.1 controller. (Default value)
- ▶ Disabled     Disable USB 1.1 controller.

## ☞ USB 2.0 Controller

Disable this function if you are not using the onboard USB feature.

- ▶ Enabled      Enable USB 2.0 controller. (Default value)
- ▶ Disabled     Disable USB 2.0 controller.

## ☞ USB Keyboard Support

- ▶ Enabled      Enable USB keyboard support.
- ▶ Disabled     Disable USB keyboard support. (Default value)



### ☛ **USB Mouse Support**

- ▶▶ Enabled      Enable USB mouse support.
- ▶▶ Disabled     Disable USB mouse support. (Default v alue)

### ☛ **On-Chip LAN Boot ROM**

This function decide whether to invoke the boot ROM of the onboard LAN chip.

- ▶▶ Disabled     Disable this function. (Default Value)
- ▶▶ Enabled      Enable this function.

### ☛ **Onboard Serial Port 1**

- ▶▶ Auto          BIOS will automatically setup the port 1 address.
- ▶▶ 3F8/IRQ4     Enable onboard Serial port 1 and address is 3F8. (Default v alue)
- ▶▶ 2F8/IRQ3     Enable onboard Serial port 1 and address is 2F8.
- ▶▶ 3E8/IRQ4     Enable onboard Serial port 1 and address is 3E8.
- ▶▶ 2E8/IRQ3     Enable onboard Serial port 1 and address is 2E8.
- ▶▶ Disabled     Disable onboard Serial port 1.

### ☛ **Onboard Serial Port 2**

- ▶▶ Auto          BIOS will automatically setup the port 2 address.
- ▶▶ 3F8/IRQ4     Enable onboard Serial port 2 and address is 3F8.
- ▶▶ 2F8/IRQ3     Enable onboard Serial port 2 and address is 2F8. (Default v alue)
- ▶▶ 3E8/IRQ4     Enable onboard Serial port 2 and address is 3E8.
- ▶▶ 2E8/IRQ3     Enable onboard Serial port 2 and address is 2E8.
- ▶▶ Disabled     Disable onboard Serial port 2.

### ☛ **Onboard Parallel port**

This feature allows you to select from a given set of parameters if the parallel port uses the onboard I/O controller.

- ▶▶ 378/IRQ7     Enable onboard LPT port and address is 378/IRQ7. (Default v alue)
- ▶▶ 278/IRQ5     Enable onboard LPT port and address is 278/IRQ5.
- ▶▶ Disabled     Disable onboard LPT port.
- ▶▶ 3BC/IRQ7     Enable onboard LPT port and address is 3BC/IRQ7.

### ☛ **Parallel Port Mode**

- ▶▶ SPP          Using Parallel port as Standard Parallel Port. (Default v alue)
- ▶▶ EPP          Using Parallel port as Enhanced Parallel Port.
- ▶▶ ECP          Using Parallel port as Extended Capabilities Port.
- ▶▶ ECP+EPP     Using Parallel port as ECP & EPP mode.

### ☛ **Game Port Address**

- ▶▶ 201          Set Game Port Address to 201. (Default v alue)
- ▶▶ 209          Set Game Port Address to 209.
- ▶▶ Disabled     Disable this function.

### ☛ **Midi Port Address**

- ▶▶ 300          Set Midi Port Address to 300.
- ▶▶ 330          Set Midi Port Address to 330.
- ▶▶ Disabled     Disable this function.(Default v alue)

### ☛ **Midi Port IRQ**

- ▶▶ 5             Set Midi Port IRQ to 5.
- ▶▶ 10            Set Midi Port IRQ to 10. (Default v alue)

# Power Management Setup

CMOS Setup Utility-Copyright (C) 1984-2004 Award Software  
Power Management Setup

ACPI Suspend Type	[S1(POS)]	Item Help
x USB Device Wake-Up from S3	[Disabled]	Menu Level ▶
Power LED in S1 state	[Blinking]	[S1]
Soft-Off by PWRBTN	[Instant-Off]	Set suspend type to
AC Back Function	[Soft-Off]	Power On Suspend under
Keyboard Power On	[Disabled]	ACPI OS
Mouse Power On	[Disabled]	
PME Event Wake Up	[Enabled]	[S3]
ModemRingOn/WakeOnLan	[Enabled]	Set suspend type to
Resume by Alarm	[Disabled]	Suspend to RAM under
x Date (of Month) Alarm	Everyday	ACPI OS
x Time (hh:mm:ss) Alarm	0 : 0 : 0	
↑↓←→: Move    Enter: Select    +/-/PU/PD: Value    F10: Save    ESC: Exit    F1: General Help F5: Previous Values    F6: Fail-Save Default    F7: Optimized Defaults		

- ☞ **ACPI Suspend Type**
  - ▶▶ S1(POS)            Set ACPI suspend type to S1. (Default value)
  - ▶▶ S3(STR)            Set ACPI suspend type to S3.
- ☞ **USB Device Wake-Up From S3**

This function will available when "ACPI Suspend Type" set at "S3/STR".

  - ▶▶ Disabled            USB device can't wake up system from S3.
  - ▶▶ Enabled             USB device can wake up system from S3. (Default value)
- ☞ **Power LED in S1 state**
  - ▶▶ Blinking            In standby mode(S1), power LED will blink. (Default value)
  - ▶▶ Dual/Off            In standby mode(S1):
    - a. If you use single color LED, power LED will turn off.
    - b. If you use dual color LED, power LED will turn to another color.
- ☞ **Soft-off by PWR-BTTON**
  - ▶▶ Instant-off         Press power button then Power off instantly. (Default value)
  - ▶▶ Delay 4 Sec.        Press power button 4 sec to Power off. Enter suspend if button is pressed less than 4 sec.
- ☞ **AC Back Function**
  - ▶▶ Soft-Off            Always in Off state when AC back to the system. (Default value)
  - ▶▶ Full-On             Always power on the system when AC back.
  - ▶▶ Memory             System power on depends on the status before AC lost.
- ☞ **Keyboard Power On**
  - ▶▶ Disabled            Disable this function. (Default value)
  - ▶▶ Password            Enter from 1 to 5 characters to set the keyboard power on password.
  - ▶▶ Keyboard 98        If your keyboard has a "POWER Key" button, you can press the key to power on your system.
- ☞ **Mouse Power On**
  - ▶▶ Disabled            Disabled this function. (Default value)
  - ▶▶ Enabled             Power on system by mouse event.

### ☞ PME Event Wake Up

When set at Enabled, any PCI-PM event can awake the system from a PCI-PM controlled stated. This feature requires an ATX power supply that provides at least 1A on the +5VSB lead.

- ▶ Disabled                    Disable this function.
- ▶ Enabled                    Enable PME as wake up event. (Default value)

### ☞ ModemRingOn/WakeOnLan

An incoming call via modem or an input signal comes from the other client server on the LAN can awake the system from any suspend state.

- ▶ Disabled                    Disable Modem Ring on function.
- ▶ Enabled                    Enable Modem Ring on function. (Default value)

### ☞ Resume by Alarm

You can set "Resume by Alarm" item to enabled and key in Date/time to power on system.

- ▶ Disabled                    Disable this function. (Default Value)
- ▶ Enabled                    Enable alarm function to POWER ON system.

If RTC Alarm Lead To Power On is Enabled.

Date (of Month) Alarm :            Everyday, 1-31

Time (hh: mm: ss) Alarm :        (0-23) : (0-59) : (0-59)

### ☞ KB Power ON Password

- ▶ Enter                    Input password (from 1 to 5 characters) and press Enter to set the keyboard power on password.

## PnP/PCI Configurations

CMOS Setup Utility-Copyright (C) 1984-2004 Award Software  
PnP/PCI Configurations

PCI 1 IRQ Assignment	[Auto]	Item Help
PCI 2 IRQ Assignment	[Auto]	Menu Level ▶
PCI 3 IRQ Assignment	[Auto]	Device(s) using this INT:
		Display Cntrlr -Bus 1 Dev 0 Func 0
↑↓←→: Move    Enter: Select    +/-/PU/PD: Value    F10: Save    ESC: Exit    F1: General Help F5: Previous Values    F6: Fail-Save Default    F7: Optimized Defaults		

### ☞ PCI 1 IRQ Assignment

- ▶ Auto                    Auto assign IRQ to PCI 1. (Default value)
- ▶ 3,4,5,7,9,10,11,12,14,15    Set IRQ 3,4,5,7,9,10,11,12,14,15 to PCI 1.

### ☞ PCI 2 IRQ Assignment

- ▶ Auto                    Auto assign IRQ to PCI 2. (Default value)
- ▶ 3,4,5,7,9,10,11,12,14,15    Set IRQ 3,4,5,7,9,10,11,12,14,15 to PCI 2.

### ☞ PCI 3 IRQ Assignment

- ▶ Auto                    Auto assign IRQ to PCI 3. (Default value)
- ▶ 3,4,5,7,9,10,11,12,14,15    Set IRQ 3,4,5,7,9,10,11,12,14,15 to PCI 3.

# PC Health Status

CMOS Setup Utility-Copyright (C) 1984-2004 Award Software  
PC Health Status

Vcore	OK	Item Help
25VSTR	OK	Menu Level ▶
+3.3V	OK	
+12V	OK	
Current System Temperature	32°C	
Current CPU Temperature	45°C	
Current CPU FAN Speed	4687 RPM	
Current SYSTEM FAN Speed	0 RPM	
CPU FAN Fail Warning	[Disabled]	
SYSTEM FAN Fail Warning	[Disabled]	
↑↓←→: Move    Enter: Select    +/-/PU/PD: Value    F10: Save    ESC: Exit    F1: General Help F5: Previous Values    F6: Fail-Save Default    F7: Optimized Defaults		

- ☞ **Current Voltage (V) Vcore / 25VSTR / +3.3V / +12V**
  - ▶▶ Detect system's voltage status automatically.
- ☞ **Current System/CPU Temperature**
  - ▶▶ Detect system/CPU temperature automatically.
- ☞ **Current CPU/SYSTEM FAN Speed (RPM)**
  - ▶▶ Detect CPU/system Fan speed status automatically.
- ☞ **CPU FAN Fail Warning**
  - ▶▶ Disabled      Fan warning function disable. (Default value)
  - ▶▶ Enabled      Fan warning function enable.
- ☞ **SYSTEM FAN Fail Warning**
  - ▶▶ Disabled      Fan warning function disable. (Default value)
  - ▶▶ Enabled      Fan warning function enable.

# Frequency/Voltage Control

CMOS Setup Utility-Copyright (C) 1984-2004 Award Software  
Frequency/Voltage Control

Auto Detect PCI/DIMM Clk	[Enabled]	Item Help
Spread Spectrum	[Enabled]	Menu Level ▶
CPU Host Clock Control	[Disabled]	
x CPU Clock	133MHz	
DRAM Clock (MHz)	[By SPD]	
AGP OverVoltage Control	[Auto]	
DIMM OverVoltage Control	[Auto]	
↑↓←→: Move    Enter: Select    +/-/PU/PD: Value    F10: Save    ESC: Exit    F1: General Help F5: Previous Values    F6: Fail-Save Default    F7: Optimized Defaults		



Incorrect using these features may cause your system broken. For power End-User use only!

## Auto Detect PCI/DIMM Clk

- ▶ Disabled            Disable this function.
- ▶ Enabled            Auto detect PCI/DIMM clock. (Default value)

## Spread Spectrum

- ▶ Disabled            Disable this function.
- ▶ Enabled            Enable clock spread spectrum. (Default value)

## CPU Host Clock Control

Note: If system hangs up before enter CMOS setup utility, wait for 20 sec for times out reboot. When time out occur, system will reset and run at CPU default Host clock at next boot.

- ▶ Disabled            Disable CPU Host Clock Control. (Default value)
- ▶ Enabled            Enable CPU Host Clock Control.

## CPU Clock

- ▶ 100                    Set CPU Host Clock to 100MHz-132MHz.
- ▶ 133                    Set CPU Host Clock to 133MHz-165MHz.
- ▶ 166                    Set CPU Host Clock to 166MHz-199MHz.

## DRAM Clock (MHz)

- Wrong frequency may make system can't boot, clear CMOS to overcome wrong frequency issue.
- ▶ By SPD              Set memory frequency by DRAM SPD data. (Default value)
- ▶ 133-DDR266        If you use DDR266 DRAM module, please set at "133-DDR 266".
- ▶ 166-DDR333        If you use DDR333 DRAM module, please set at "166-DDR 333".

## AGP OverVoltage Control

Increase AGP voltage may get stable for over-clock. But it may damage to AGP card when enable this feature.

- ▶ Auto                    Supply voltage as AGP required. (Default value)
- ▶ +0.1V                Increase AGP voltage +0.1V.

- ▶ +0.2V Increase AGP voltage +0.2V.
- ▶ +0.3V Increase AGP voltage +0.3V.

### ◀ DIMM OverVoltage Control

Increase DIMM voltage may get stable for over-clock. But it may damage to memory module when enable this feature.

- ▶ Auto Supply voltage as DIMM required. (Default value)
- ▶ +0.1V Increase DIMM voltage +0.1V.
- ▶ +0.2V Increase DIMM voltage +0.2V.
- ▶ +0.3V Increase DIMM voltage +0.3V.

## Load Fail-Safe Defaults

CMOS Setup Utility-Copyright (C) 1984-2004 Award Software

▶ Standard CMOS Features	Load Fail-Safe Defaults
▶ Advanced BIOS Features	Load Optimized Defaults
▶ Integrated Peripherals	Set Supervisor Password
▶ Power Management Setup	Set User Password
▶ PnP/PCI Configurations	Load Fail-Safe Defaults (Y/N)? N
▶ PC Health Status	Enter System Logging
▶ Frequency/Voltage Control	
ESC: Quit	↑↓←→: Select Item
F8: Q-Flash	F10: Save & Exit Setup
Load Fail-Safe Defaults	

Fail-Safe defaults contain the most appropriate values of the system parameters that allow minimum system performance.

## Load Optimized Defaults

CMOS Setup Utility-Copyright (C) 1984-2004 Award Software

▶ Standard CMOS Features	Load Fail-Safe Defaults
▶ Advanced BIOS Features	Load Optimized Defaults
▶ Integrated Peripherals	Set Supervisor Password
▶ Power Management Setup	Set User Password
▶ PnP/PCI Configurations	Load Optimized Defaults (Y/N)? N
▶ PC Health Status	Enter System Logging
▶ Frequency/Voltage Control	
ESC: Quit	↑↓←→: Select Item
F8: Q-Flash	F10: Save & Exit Setup
Load Optimized Defaults	

Selecting this field loads the factory defaults for BIOS and Chipset Features which the system automatically detects.

## Set Supervisor/User Password

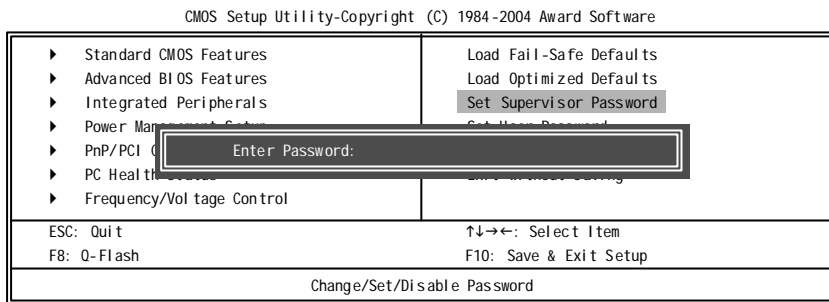

When you select this function, the following message will appear at the center of the screen to assist you in creating a password.

Type the password, up to eight characters, and press <Enter>. You will be asked to confirm the password. Type the password again and press <Enter>. You may also press <Esc> to abort the selection and not enter a password.

To disable password, just press <Enter> when you are prompted to enter password. A message "PASSWORD DISABLED" will appear to confirm the password being disabled. Once the password is disabled, the system will boot and you can enter Setup freely.

The BIOS Setup program allows you to specify two separate passwords:

SUPERVISOR PASSWORD and a USER PASSWORD. When disabled, anyone may access all BIOS Setup program function. When enabled, the Supervisor password is required for entering the BIOS Setup program and having full configuration fields, the User password is required to access only basic items.

If you select "System" at "Password Check" in Advance BIOS Features Menu, you will be prompted for the password every time the system is rebooted or any time you try to enter Setup Menu.

If you select "Setup" at "Password Check" in Advance BIOS Features Menu, you will be prompted only when you try to enter Setup.

## Save & Exit Setup

CMOS Setup Utility-Copyright (C) 1984-2004 Award Software

<ul style="list-style-type: none"> <li>▶ Standard CMOS Features</li> <li>▶ Advanced BIOS Features</li> <li>▶ Integrated Peripherals</li> <li>▶ Power Management Setup</li> <li>▶ PnP/PCI Devices</li> <li>▶ PC Health Status</li> <li>▶ Frequency/Voltage Control</li> </ul>	<ul style="list-style-type: none"> <li>Load Fail-Safe Defaults</li> <li>Load Optimized Defaults</li> <li>Set Supervisor Password</li> <li>Set User Password</li> <li>Exit Without Saving</li> </ul>
<div style="border: 2px solid black; padding: 2px; display: inline-block;">Save to CMOS and EXIT (Y/N)? Y</div>	
ESC: Quit	↑↓←: Select Item
F8: Q-Flash	F10: Save & Exit Setup
Save & Exit Setup	

Type "Y" will quit the Setup Utility and save the user setup value to RTC CMOS.  
Type "N" will return to Setup Utility.

## Exit Without Saving

CMOS Setup Utility-Copyright (C) 1984-2004 Award Software

<ul style="list-style-type: none"> <li>▶ Standard CMOS Features</li> <li>▶ Advanced BIOS Features</li> <li>▶ Integrated Peripherals</li> <li>▶ Power Management Setup</li> <li>▶ PnP/PCI Devices</li> <li>▶ PC Health Status</li> <li>▶ Frequency/Voltage Control</li> </ul>	<ul style="list-style-type: none"> <li>Load Fail-Safe Defaults</li> <li>Load Optimized Defaults</li> <li>Set Supervisor Password</li> <li>Set User Password</li> <li>Exit Without Saving</li> </ul>
<div style="border: 2px solid black; padding: 2px; display: inline-block;">Quit Without Saving (Y/N)? N</div>	
ESC: Quit	↑↓←: Select Item
F8: Q-Flash	F10: Save & Exit Setup
Abandon all Data	

Type "Y" will quit the Setup Utility without saving to RTC CMOS.  
Type "N" will return to Setup Utility.



# Chapter 3 Install Drivers

## Install Drivers



### Pictures below are shown in Windows XP

Insert the driver CD-title that came with your motherboard into your CD-ROM drive, the driver CD-title will auto start and show the installation guide. If not, please double click the CD-ROM device icon in "My computer", and execute the setup.exe.

## Install Chipset Drivers

This page shows the drivers that need to be installed for the system. Click each item to install the driver manually or switch to the  to install the drivers automatically.



The "Xpress Install" uses the "Click and Go" technology to install the drivers automatically. Just select the drivers you want then click the "GO" button. The  will finish the installation for you automatically.

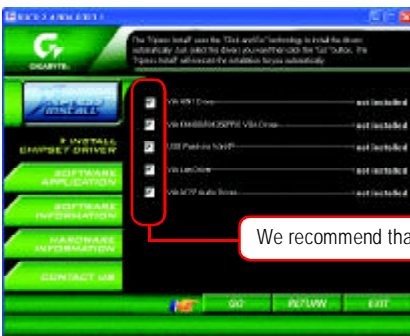

Message: Some device drivers will restart your system automatically. After restarting your system the "Xpress Install" will continue to install other drivers.

We recommend that you install all components in the list.



Driver install finished !  
You have to reboot system !

## Item Description

- VIA 4IN1 Driver  
For INF, AGP, IDE and DMA driver.
- VIA KM400 / KM266PRO VGA Driver  
For KM400 / KM266PRO driver.
- USB Patch for WinXP  
This patch driver can help you to resolve the USB device wake up S3 hang up issue in XP.
- VIA Lan Driver  
For VIA Phy family Lan driver.
- VIA AC97 Audio Driver  
Audio driver for VIA codec chipset.
- VIA USB 2.0 Controller  
For VIA VT8233 (VT6203) / VIA VT8235 south bridge.



*For USB2.0 driver support under Windows XP operating system, please use Windows Service Pack. After install Windows Service Pack, it will show a question mark "?" in "Universal Serial Bus controller" under "Device Manager". Please remove the question mark and restart the system (System will auto-detect the right USB2.0 driver).*



## Contact Us

---

- **Taiwan (Headquarters)**

GIGA-BYTE TECHNOLOGY CO., LTD.  
Address: No.6, Bau Chiang Road, Hsin-Tien, Taipei Hsien,  
Taiwan

TEL: +886 (2) 8912-4888

FAX: +886 (2) 8912-4003

Tech. Support :

<http://tw.giga-byte.com/TechSupport/ServiceCenter.htm>

Non-Tech. Support (Sales/Marketing) :

<http://gigts.gigabyte.com.tw/nontech.asp>

WEB address (English) : <http://www.gigabyte.com.tw>

WEB address (Chinese) : <http://chinese.giga-byte.com>

---

- **U.S.A.**

G.B.T. INC.

Address: 17358 Railroad St, City of Industry, CA 91748.

TEL: +1 (626) 854-9338

FAX: +1 (626) 854-9339

Tech. Support :

<http://www.giga-byte.com/TechSupport/ServiceCenter.htm>

Non-Tech. Support (Sales/Marketing) :

<http://gigts.gigabyte.com.tw/nontech.asp>

WEB address : <http://www.giga-byte.com>

---

- **Germany**

G.B.T. TECHNOLOGY TRADING GMBH

Address: Friedrich-Ebert-Damm 112 22047 Hamburg

TEL: +49-40-2533040 (Sales)

+49-1803-428468 (Tech.)

FAX: +49-40-25492343 (Sales)

+49-1803-428329 (Tech.)

Tech. Support :

<http://de.giga-byte.com/TechSupport/ServiceCenter.htm>

Non-Tech. Support (Sales/Marketing) :

<http://gigts.gigabyte.com.tw/nontech.asp>

WEB address : <http://www.gigabyte.de>

---

---

- **Japan**

NIPPON GIGA-BYTE CORPORATION

WEB address : <http://www.gigabyte.co.jp>

---

- **Singapore**

GIGA-BYTE SINGAPORE PTE. LTD.

Tech. Support :

<http://tw.giga-byte.com/TechSupport/ServiceCenter.htm>

Non-Tech. Support (Sales/Marketing) :

<http://gigts.gigabyte.com.tw/nontech.asp>

---

- **U.K.**

G.B.T. TECH. CO., LTD.

Address: GUnit 13 Avant Business Centre 3 Third Avenue,  
Denbigh West Bletchley Milton Keynes, MK1 1DR, UK, England

TEL: +44-1908-362700

FAX: +44-1908-362709

Tech. Support :

<http://uk.giga-byte.com/TechSupport/ServiceCenter.htm>

Non-Tech. Support (Sales/Marketing) :

<http://gigts.gigabyte.com.tw/nontech.asp>

WEB address : <http://uk.giga-byte.com>

---

- **The Netherlands**

GIGA-BYTE TECHNOLOGY B.V.

TEL: +31 40 290 2088

NL Tech.Support: 0900-GIGABYTE (0900-44422983)

BE Tech.Support: 0900-84034

FAX: +31 40 290 2089

Tech. Support :

<http://nz.giga-byte.com/TechSupport/ServiceCenter.htm>

Non-Tech. Support (Sales/Marketing) :

<http://gigts.gigabyte.com.tw/nontech.asp>

WEB address : <http://www.giga-byte.nl>

---

---

- **China**

NINGBO G.B.T. TECH. TRADING CO., LTD.

Tech. Support :

<http://cn.giga-byte.com/TechSupport/ServiceCenter.htm>

Non-Tech. Support (Sales/Marketing) :

<http://ggts.gigabyte.com.tw/nontech.asp>

WEB address : <http://www.gigabyte.com.cn>

**Shanghai**

TEL: +86-021-63410999

FAX: +86-021-63410100

**Beijing**

TEL: +86-010-82886651

FAX: +86-010-82888013

**Wuhan**

TEL: +86-027-87851061

FAX: +86-027-87851330

**GuangZhou**

TEL: +86-020-87586074

FAX: +86-020-85517843

**Chengdu**

TEL: +86-028-85236930

FAX: +86-028-85256822

**Xian**

TEL: +86-029-85531943

FAX: +86-029-85539821

**Shenyang**

TEL: +86-024-23960918

FAX: +86-024-23960918-809

---

---

- **Australia**

GIGABYTE TECHNOLOGY PTY. LTD.

Tech. Support :

<http://www.giga-byte.com.au/TechSupport/ServiceCenter.htm>

Non-Tech. Support (Sales/Marketing) :

<http://ggts.gigabyte.com.tw/nontech.asp>

WEB address : <http://www.giga-byte.com.au>

---

- **France**

GIGABYTE TECHNOLOGY FRANCES S.A.R.L.

Tech. Support :

<http://tw.giga-byte.com/TechSupport/ServiceCenter.htm>

Non-Tech. Support (Sales/Marketing) :

<http://ggts.gigabyte.com.tw/nontech.asp>

WEB address : <http://www.gigabyte.fr>

---

- **Russia**

Moscow Representative Office Of Giga-Byte Technology Co., Ltd.

Tech. Support :

<http://tw.giga-byte.com/TechSupport/ServiceCenter.htm>

Non-Tech. Support (Sales/Marketing) :

<http://ggts.gigabyte.com.tw/nontech.asp>

WEB address : <http://www.gigabyte.ru>

---

- **Poland**

Representative Office Of Giga-Byte Technology Co., Ltd.  
POLAND

Tech. Support :

<http://tw.giga-byte.com/TechSupport/ServiceCenter.htm>

Non-Tech. Support (Sales/Marketing) :

<http://ggts.gigabyte.com.tw/nontech.asp>

WEB address : <http://www.gigabyte.pl>

---